

 **DATALOGIC**

PowerScan™ PD953X
Industrial Corded Handheld
Area Imager Bar Code Reader



Quick Reference Guide

Datalogic USA, Inc.

959 Terry Street

Eugene, OR 97402

USA

Telephone: (541) 683-5700

Fax: (541) 345-7140

©2013-2018 Datalogic S.p.A. and/or its affiliates

♦ All rights reserved. ♦ Without limiting the rights under copyright, no part of this documentation may be reproduced, stored in or introduced into a retrieval system, or transmitted in any form or by any means, or for any purpose, without the express written permission of Datalogic S.p.A. and/or its affiliates.

Owners of Datalogic products are hereby granted a non-exclusive, revocable license to reproduce and transmit this documentation for the purchaser's own internal business purposes. Purchaser shall not remove or alter any proprietary notices, including copyright notices, contained in this documentation and shall ensure that all notices appear on any reproductions of the documentation.

Should future revisions of this manual be published, you can acquire printed versions by contacting your Datalogic representative. Electronic versions may either be downloadable from the Datalogic website (www.datalogic.com) or provided on appropriate media. If you visit our website and would like to make comments or suggestions about this or other Datalogic publications, please let us know via the "Contact Datalogic" page.

Disclaimer

Datalogic has taken reasonable measures to provide information in this manual that is complete and accurate, however, Datalogic reserves the right to change any specification at any time without prior notice.

Datalogic and the Datalogic logo are registered trademarks of Datalogic S.p.A. in many countries, including the U.S. and the E.U. PowerScan is a trademark of Datalogic S.p.A. and/or its affiliates, registered in many countries, including the U.S. and the E.U. All other brand and product names may be trademarks of their respective owners.

Patents

See www.patents.datalogic.com for patent list.

See the Regulatory Addendum included with your product for additional regulatory, safety and legal information.



Table of Contents

END USER SOFTWARE LICENSE AGREEMENT (EULA)	iii
Software Product Policy	vi
Description	1
General Features	1
Setting Up the Reader	2
Connecting the Cable	3
Using the PowerScan™ PD953X	4
Selecting the Interface Type	5
Interface Selection	5
Configuring the Interface	5
Scancode Tables.....	8
Keyboard Interface	8
Country Mode.....	9
Caps Lock State.....	13
Numlock.....	14
Programming	15
Using Programming Bar Codes	15
Configure Other Settings	15
Resetting Product Defaults	15
Reading Parameters	16
Good Read Green Spot Duration	16
Operating Modes	17
Scan Mode	17
Scan Mode	18
Motion Aiming Control	18
Pick Mode	19
Multiple Label Reading	19
Technical Specifications	20
LED and Beeper Indications	23
Error Codes	26
Cleaning	27
Datalogic Limited Factory Warranty	28
Ergonomic Recommendations	30
Support Through the Website	30

END USER SOFTWARE LICENSE AGREEMENT (EULA)

NOTICE TO END USER: BY DOWNLOADING OR INSTALLING THE SOFTWARE, OR BY USING THE DATALOGIC PRODUCT THAT INCLUDES THIS SOFTWARE, THE END USER CONSENTS TO BE BOUND BY THIS AGREEMENT. IF THE END USER DOES NOT AGREE WITH ALL OF THE TERMS OF THIS AGREEMENT, THEN DATALOGIC IS NOT WILLING TO LICENSE THE SOFTWARE AND THE END USER IS NOT ALLOWED TO DOWNLOAD, INSTALL OR USE THE SOFTWARE OR THE DATALOGIC PRODUCT---

This End User License Agreement ("EULA") is between Datalogic IP Tech S.r.l. having its registered office at Via San Vitalino 13, 40012 Calderara di Reno (Bologna), Italy ("Datalogic"), and you, either an individual or a single entity, ("End User or "You") who has purchased one or more PowerScan™ 95XX ("Datalogic Product") subject to the terms and conditions provided in any relevant purchase or sale contract. This EULA applies to the software contained in the Datalogic Product ("Embedded Software") and to any other software, to the extent applicable, offered as optional application software ("Application Software" that together with "Embedded Software" is herein referred to as "Software"). Any Open Source used in a conjunction with the Software is subject to the Open Source licenses available at the following website: <http://www.datalogic.com/oss>.

1. Grant of License

1.1 Datalogic grants to End User, a personal, non-exclusive, non-transferable, non sub licensable, revocable, limited license to use the Software, solely on the Datalogic Product in which it is embedded or for which it is intended for use, in machine-readable form only, solely for End User's internal business purposes.

1.2 End Users shall not distribute, sublicense, rent, loan, lease, assign, export, re-export, resell, ship or divert or cause to be exported, re-exported, resold, shipped or diverted, directly or indirectly, the Software under this Agreement. End User shall not, and shall not permit others to: (i) modify, translate, decompile, reverse engineer, disassemble, or extract the inner workings of the Software, (ii) copy the functionality of the Datalogic Products; (iii) remove any proprietary notices, marks, labels, or logos from the Datalogic Products; (iv) rent or transfer all or some of the Software to any other party without Datalogic's prior written consent.

1.3. Title to the licensed Software shall be and remain with Datalogic or the third party from whom Datalogic has obtained a license right. This Agreement does not grant to End User any intellectual property rights. As used in this Agreement the term "purchase" or its equivalent when applied to the Software shall mean "acquire under license". End User is not entitled to receipt or use of the source code of any licensed Software.

1.4 Portions of the Datalogic Product are protected by the relevant and applicable patent and copyright laws, international treaty provisions, and other applicable laws. Therefore, End User must treat the Datalogic Product like any other copyrighted material (e.g., a book or musical recording) except that End User may make one copy of the Software solely for back-up purposes. Unauthorized duplication of the Software constitutes copyright infringement.

1.5 Any use of the Software outside of the conditions set forth herein is strictly prohibited and will be deemed a breach of this Agreement resulting in immediate termination of this Agreement. In the event of a breach of this Agreement, Datalogic will be entitled to all available remedies at law or in equity (including but not limiting to immediate termination of the license without notice, immediate injunctive relief and repossession of all Datalogic Products).

1.6 Without prejudice of the foregoing, End User grants to Datalogic and its independent accountants or consultants the right to examine End User's books, records and accounts during End User's normal business hours to verify compliance with this Agreement. In the event such audit discloses non-compliance with this Agreement, Datalogic shall be entitled to immediately terminate the Agreement, request End User to promptly pay all (additional) license fees due and any further damages, if any.

2. License Fee

License fees shall be due by End User to Datalogic according to the terms provided for in the relevant contract for the purchase of the Datalogic Product.

3. Termination

Without prejudice to any other rights or remedies Datalogic may have, Datalogic may terminate this Agreement if End User fails to comply with the terms and conditions of this Agreement. Datalogic may terminate this Agreement by offering you a superseding Agreement for the Software or any replacement or modified version of or upgrade to the Software and conditioning your continued use of the Software or such replacement, modified or upgraded version on your acceptance of such superseding Agreement. In addition, either party may terminate this Agreement at any time. Subject to the foregoing, termination shall be effective upon notice to the other party. In the event that this Agreement terminates for any reason, End User's license to use the Software will immediately terminate, and End User must immediately stop using the Software, destroy all copies of the Software and all of its component parts, and, upon request, provide an affidavit certifying your compliance with the foregoing. The provisions of Sub-sections 1.2, 1.3, 1.4, 1.5, 4, 5, 6, 8,

and 12 shall survive termination of this Agreement.

4. Limited Warranty

Datalogic warrants that, under normal use and operation, the Software will conform substantially to the applicable Datalogic Product documentation for the period specified in the same, provided that the Software is used with the Datalogic Product. Datalogic's entire liability and End User's sole and exclusive remedy for any breach of the foregoing limited warranty will be, at Datalogic's option, the provision of a downloadable patch or replacement software.

Datalogic does not warrant (i) that Software will meet End User's requirements; (ii) that Software will be uninterrupted or defect error free; (iii) any non conformity derived from unauthorized use, and/or improper installation or repair not in compliance with Datalogic Product documentation. End User agrees that the existence of such non conformities or errors and Datalogic's inability to remedy such errors shall not constitute a breach of this Agreement.

EXCEPT AS PROVIDED IN THIS AGREEMENT, THE DATALOGIC PRODUCT IS PROVIDED "AS IS" AND DATALOGIC MAKES NO WARRANTIES OF ANY KIND, EXPRESS OR IMPLIED, WRITTEN OR ORAL, WITH RESPECT TO THE DATALOGIC PRODUCT OR SOFTWARE, AND SPECIFICALLY DISCLAIMS THE IMPLIED WARRANTIES OF MERCHANTABILITY AND FITNESS FOR A PARTICULAR PURPOSE.

5. Limitation of Liability

EXCEPT AS PROVIDED IN THIS AGREEMENT, NEITHER DATALOGIC NOR ITS LICENSORS SHALL BE LIABLE FOR ANY CLAIMS AGAINST END USER BY ANY OTHER PARTY. IN NO EVENT SHALL DATALOGIC'S LIABILITY FOR DAMAGES, IF ANY, WHETHER BASED UPON CONTRACT, TORT (INCLUDING NEGLIGENCE), PRODUCT LIABILITY, STRICT LIABILITY, WARRANTY, OR ANY OTHER BASIS, EXCEED THE PRICE OR FEE PAID BY END USER FOR THE DATALOGIC PRODUCT. UNDER NO CIRCUMSTANCES SHALL DATALOGIC OR ITS LICENSORS BE LIABLE TO END USER OR ANY THIRD PARTY FOR LOST PROFITS, LOST DATA, INTERRUPTION OF BUSINESS OR SERVICE, OR FOR ANY OTHER SPECIAL, CONSEQUENTIAL, CONTINGENT, INDIRECT, INCIDENTAL, PUNITIVE, EXEMPLARY, OR OTHER SIMILAR DAMAGES, EVEN IF DATALOGIC OR ITS LICENSORS HAVE BEEN ADVISED OF THE POSSIBILITY OF SUCH DAMAGES. END USER MUST BRING ANY ACTION UNDER THIS AGREEMENT WITHIN 12 (TWELVE) MONTHS AFTER THE CAUSE OF ACTION ARISES.

6. Indemnification

To the maximum extent permitted by law, End User agrees to defend, indemnify and hold harmless Datalogic, its affiliates and their respective directors, officers, employees and agents from and against any and all claims, actions, suits or proceedings, as well as any and all losses, liabilities, damages, costs and expenses (including reasonable attorney's fees) arising out of or accruing from or related to Licensee's failure to comply with the terms of this Agreement, including but not limited to (1) non compliance with any applicable laws or regulations with Datalogic product documentation, (2) unauthorized use or disclosure of Software, and (3) use of Software in combination with software, hardware, systems, or other items not provided by Datalogic.

7. Support

End User may request support for Software from Datalogic at Datalogic's standard support fees and under Datalogic's standard support terms and conditions in effect at the time the support is requested.

8. Government Restricted Rights; International Use

8.1 Use, duplication, or disclosure of the Software by the U.S. Government is subject to the restrictions for computer software developed at private expense as set forth in the U.S. Federal Acquisition Regulations at FAR 52.227-14(g), or 52.227-19 or in the Rights in Technical Data and Computer Software clause at DFARS 252.227-7013(c)(1)(ii), whichever is applicable.

8.2 If End User is using the Datalogic Product outside of the United States, End User must comply with the applicable local laws of the country in which the Datalogic Product is used and with U.S. export control laws. Without prejudice of the foregoing, the End User agrees to not export or re-export the Software, any part thereof, or any process or service that is the direct product of the Software to any country, person or entity subject to U.S. export restrictions. End User specifically agrees not to export or re-export any of the Software: (i) to any country to which the U.S. has embargoed or restricted the export of goods or services or to any national of any such country, wherever located, who intends to transmit or transport the Software back to such country; (ii) to any person or entity who you know or have reason to know will utilize the Software in the design, development or production of nuclear, chemical or biological weapons; or (iii) to any person or entity who has been prohibited from participating in U.S. export transactions by any federal agency of the U.S. government. End User warrants and represents that neither the U.S. Commerce Department, Bureau of Export Administration nor any other U.S. federal agency has suspended, revoked or denied its export privileges.

9. Third Party Software

The Datalogic Product may contain one or more items of third party software which use is governed by separate third party license, unless otherwise stated.

10. Open Source Software

Portions of the Software include or operate with Open Source software ("Open Source Software").

Open Source Software is software covered by a publicly available license governed solely under Copyright law, whereas the complete terms and obligations of such license attach to a licensee solely through the act of copying, using and/or distributing the licensed software, such obligations often include one or more of attribution obligations, distribution obligations, copyleft obligations, and intellectual property encumbrances. The use of any Open Source Software is subject to the terms and conditions of this Agreement as well as the terms and conditions of the corresponding license of each Open Source Software package. If there is a conflict between the terms and conditions of this Agreement and the terms and conditions of the Open Source Software license, the applicable Open Source Software license will take precedence. Datalogic is required to reproduce the software licenses, acknowledgments and copyright notices as provided by the authors and owners, thus, all such information is provided in its native language form, without modification or translation. Please reference and review the above mentioned information to identify which Open Source Software packages have source code provided or available.

11. Notices

All notices required or authorized under this Agreement shall be given in writing, and shall be effective when received, with evidence of receipt. Notices to Datalogic shall be sent to the attention of Datalogic IP Tech S.r.l., Legal & IP Department, Via San Vitalino 13, 40012 Calderara di Reno (Bologna), Italy, or such other address as may be specified by Datalogic in writing.

12. General Provisions.

12.1. Entire Agreement; Amendment. This document contains the entire agreement between the parties relating to use of the Datalogic Products and the licensing of the Software and supersedes all prior or contemporaneous agreements, written or oral, between the parties concerning the use of the Datalogic Products and licensing of the Software. This Agreement may not be changed, amended, or modified except by written document signed by Datalogic.

12.2. Waiver. A party's failure to enforce any of the terms and conditions of this Agreement shall not prevent the party's later enforcement of such terms and conditions.

12.3. Governing Law; Venue: End User agrees to the application of the laws of the country in which End User obtained the license to govern, interpret, and enforce all of End User's and Datalogic's respective rights, duties, and obligations arising from, or relating in any manner to, the subject matter of this Agreement, without regard to conflict of law principles. The United Nations Convention on Contracts for the International Sale of Goods does not apply.

All rights, duties, and obligations are subject to the courts of the country in which End User obtained the license. For licenses granted by Licensee who operates in the countries specified below, the following terms applies.

For Americas:

This Agreement is governed by the laws of the State of Oregon. This Agreement and the rights of the parties hereunder shall be governed by and construed in accordance with the laws of the State of Oregon U.S.A, without regard to the rules governing conflicts of law. The state or federal courts of the State of Oregon located in either Multnomah or Lane counties shall have exclusive jurisdiction over all matters regarding this Agreement, except that Datalogic shall have the right, at its absolute discretion, to initiate proceedings in the courts of any other state, country, or territory in which End User resides, or in which any of End User's assets are located. In the event an action is brought to enforce the terms and conditions of this Agreement, the prevailing party shall be entitled to reasonable attorneys' fees, both at trial and on appeal.

For Europe, Middle East and Africa:

This Agreement is governed by the laws of Italy. This Agreement and the rights of the parties hereunder shall be governed by and construed in accordance with the laws of Italy, without regard to the rules governing conflicts of law. Italian Court of Bologna shall have exclusive jurisdiction over all matters regarding this Agreement, except that Datalogic shall have the right, at its absolute discretion, to initiate proceedings in the courts of any other state, country, or territory in which End User resides, or in which any of End User's assets are located. In the event an action is brought to enforce the terms and conditions of this Agreement, the prevailing party shall be entitled to reasonable attorneys' fees, both at trial and on appeal.

For Asia- Pacific Countries:

The validity, interpretation and construction of the Agreement shall be governed by and construed in accordance with Laws of the Republic of Singapore. Parties expressly disclaim the application of the United Nations Convention for International Sale of Goods.

Any dispute arising out of or in connection with this contract, including any ques-

tion regarding its existence, validity or termination, shall be referred to and finally resolved by arbitration administered by the Singapore International Arbitration Centre ("SIAC") in accordance with the Arbitration Rules of the Singapore International Arbitration Centre ("SIAC Rules") for the time being in force, which rules are deemed to be incorporated by reference in this clause. The seat of the arbitration shall be Singapore.

The number of arbitrators will be three, with each side to the dispute being entitled to appoint one arbitrator. The two arbitrators appointed by the parties will appoint a third arbitrator who will act as chairman of the proceedings. Vacancies in the post of chairman will be filled by the president of the SIAC. Other vacancies will be filled by the respective nominating party. Proceedings will continue from the stage they were at when the vacancy occurred. If one of the parties refuses or otherwise fails to appoint an arbitrator within 30 days of the date the other party appoints its, the first appointed arbitrator will be the sole arbitrator, provided that the arbitrator was validly and properly appointed. All proceedings will be conducted, including all documents presented in such proceedings, in the English language. The English language version of these terms and conditions prevails over any other language version.

12.4. Attorneys' Fees. In the event an action is brought to enforce the terms and conditions of this Agreement, the prevailing party shall be entitled to reasonable attorneys' fees, both at trial and on appeal.

- END -

Software Product Policy

Datalogic reserves the right to ship its products with the latest version of software/firmware available. This provides our customers with the very latest in Datalogic software technology.

The only exception to this policy is when the buyer has a signed contract with Datalogic that clearly defines the terms and conditions for making software/firmware changes in products shipped to the buyer.

To arrange for a Software Maintenance and Support Agreement please contact your Datalogic sales person.



PowerScan™ PD953X

Description

The PowerScan™ 953X is a feature-rich and rugged area imager reader. It is offered in several different models to better fit the different needs of each customer.

The table below shows the unique features of each model:

Model P/N	Optical feature
PD953X	Standard optic, standard and low density codes
PD953X-HP	Autofocus optic, High, standard and low density codes, wide angle
PD953X-HPE	Autofocus optic, High, standard and low density codes, wide angle
PD953X-DPM	High Density optic, high and medium density codes, DPM (laser, ink jet and dot peen)

General Features

Omni-directional Operating	To read a symbol or capture an image, you simply aim the reader and pull the trigger. Since the PowerScan™ PD953X is a powerful omni-directional reader, the orientation of the symbol is not important.
Decoding	Thanks to powerful algorithms, PowerScan™ PD953X reliably decodes all major 1D (linear) barcodes, 2D stacked codes (such as PDF417), 2D matrix symbols (such as DataMatrix), postal codes (such as POSTNET, PLANET). The data stream — acquired from decoding a symbol — is rapidly sent to the host. The reader is immediately available to read another symbol.
Formatting and Concatenating	The string of a decoded code may be processed according to either a simple or advanced data formatting and be concatenated.

Imaging	PowerScan™ PD953X can also function as a camera by capturing entire images or image portions of labels, signatures, and other items.
Autoscanning	An autoscan command causes the reader to scan continuously and to monitor the central zone of its reading area.
Flash Memory	Flash technology allows you to upgrade the PowerScan™ PD953X reader as new symbologies are supported or as improved decoding algorithms become available.
USA Driver License Parsing	The reader can be set up to select and output a subset of data elements from USA Driver License PDF417 barcodes. This feature can be enabled using either Datalogic Aladdin™ or the barcodes in the USA Driver License Parsing Quick Reference Guide (QRG), available on the Datalogic website.

Setting Up the Reader

Follow the steps below to connect and get your reader up and communicating with its host.

1. Connect the Cable to the reader and the Host, shown on [page 3](#).
2. Configure the Interface (see [page 5](#)).
3. Configure the Reader starting on [page 15](#) (optional, depends on settings needed)

Connect the PowerScan™ by plugging directly into the host device as shown. The power can also be supplied through an external power supply via the Interface Cable supplied with a power jack.

Connecting the Cable

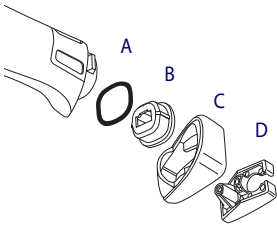

- A. Rubber gasket
- B. Cable Holder
- C. Cover
- D. Connector Holder

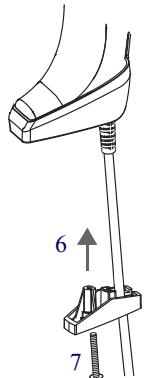
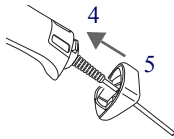
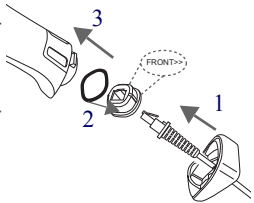

1. Slip the cable through the Cover.
2. Push the Rubber Gasket onto the Cable Holder.
3. Push the Cable Holder and gasket into the handle. Ensure that the 'Front' marking on the Cable Holder is facing out, with the arrow pointing towards the front of the scanner.
4. Insert the end of the cable into the socket of the Cable Holder.
5. Push the Cover along the cable towards the reader, and hook it over the yellow 'tooth' on the back of the handle.
6. Insert the cable through the Connector Holder, and push it up into the Cover.
7. Insert and tighten the screw to affix the cable assembly to the reader handle.



Using the PowerScan™ PD953X

The PowerScan™ PD953X normally functions by capturing and decoding bar codes. The reader is equipped with an internal Motionix™ motion-sensing function which activates the aiming system on device motion. The intelligent aiming system indicates the field of view which should be positioned over the bar code:

Table 1. Aiming System

Model P/N	Aimer pattern
PD953X / PD953X-DPM	
PD953X-HP / PD953X-HPE	

The field of view indicated by the aiming system will be smaller when the reader is closer to the bar code and larger when it is farther from the code. Symbologies with smaller bars or elements (mil size) should be read closer to the unit. Symbologies with larger bars or elements (mil size) should be read farther from the unit.

If the entire bar code is within the aiming field, you will get a good read. Successful reading is signaled by an audible tone plus a good-read green spot LED indicator.

Reference the PowerScan™ 9500 Family Product Reference Guide (PRG) for more information about this feature and other programmable settings.

Selecting the Interface Type

Upon completing the physical connection between the reader and its host, proceed directly to Interface Selection below for information and programming for the interface type the reader is connected to (for example: RS-232, Keyboard Wedge, USB, etc.) and scan the appropriate bar code to select your system's correct interface type.

Interface Selection

All models are multi-interface and support RS-232, USB and Keyboard Wedge.

Information and programming options for each interface type are provided in this section. For defaults and additional information associated with each interface, proceed to the corresponding chapter in the PowerScan™ 9500 Family PRG.

Configuring the Interface

Scan the appropriate programming bar code to select the interface type for your system.



NOTE

Unlike some other programming features and options, interface selections require that you scan only one programming bar code label. DO NOT scan an ENTER/EXIT bar code prior to scanning an interface selection bar code.

Some interfaces require the scanner to start in the disabled state when powered up. If additional scanner configuration is desired while in this state, pull the trigger and hold for 5 seconds. The scanner will change to a state that allows programming with bar codes.

RS-232

RS-232 standard interface



RS-232

RS-232 Wincor-Nixdorf



RS232-WN

RS-232 for use with OPOS/UPOS/JavaPOS



RS-232 OPOS

USB

USB Com to simulate RS-232 standard interface



USB-COM^a

USB (continued)

USB-OEM
(can be used for OPOS/UPOS/JavaPOS)



USB-OEM

a. Download the correct USB Com driver from www.datalogic.com

USB Keyboard with standard key encoding



USB-KBD

USB Keyboard with alternate key encoding



USB-KBD-ALT

USB Keyboard for Apple computers



USB-KBD-APPLE

Keyboard Interface

KEYBOARD WEDGE

IBM AT or PS/2 PCs
Standard Key Encoding



KBD-AT

IBM AT or PS/2 PCs
Standard Key Encoding without external keyboard



KBD-AT-NK

IBM AT or PS/2 PCs
w/Alternate Key



KBD-AT-ALT

IBM AT or PS/2 PCs
Alternate Key Encoding without external keyboard



KBD-AT-ALT-NK

Scancode Tables

Refer to the PowerScan™ 9500 Family PRG for information about control character emulation for keyboard interfaces.

Country Mode

This feature specifies the country/language supported by the keyboard. This option is usable only with USB-KBD and Keyboard Wedge interface without the "Alternate Key" mode.

COUNTRY MODE



ENTER/EXIT PROGRAMMING MODE



Country Mode = U.S.



Country Mode = Belgium



Country Mode = Britain



Country Mode = Croatia*

*Supports only the interfaces listed in the Country Mode feature description

COUNTRY MODE (continued)



Country Mode = Czech*



Country Mode = Denmark*



Country Mode = France



Country Mode = French Canadian*



Country Mode = Germany



Country Mode = Hungary*

*Supports only the interfaces listed in the Country Mode feature description

COUNTRY MODE (continued)

Country Mode = Italy



Country Mode = Japanese 106-key*



Country Mode = Lithuanian*



Country Mode = Norway*



Country Mode = Poland*



Country Mode = Portugal*

*Supports only the interfaces listed in the Country Mode feature description

COUNTRY MODE (continued)



Country Mode = Romania*



Country Mode = Spain



Country Mode = Sweden



Country Mode = Slovakia*







Country Mode = Switzerland*

*Supports only the interfaces listed in the Country Mode feature description

Caps Lock State

This option specifies the format in which the reader sends character data. This applies to keyboard wedge interfaces. This does not apply when an alternate key encoding keyboard is selected.

 ENTER/EXIT PROGRAMMING MODE
 Caps Lock State = Caps Lock OFF
 Caps Lock State = Caps Lock ON
 Caps Lock State = AUTO Caps Lock Enable

Numlock

This option specifies the setting of the Numbers Lock (Numlock) key while in keyboard wedge interface. This only applies to alternate key encoding interfaces. It does not apply to USB keyboard.



ENTER/EXIT PROGRAMMING MODE



Numlock = Numlock key unchanged



Numlock = Numlock key toggled

Programming

The reader is factory-configured with a set of standard default features. After scanning the interface bar code from the Interfaces section, select other options and customize your reader through use of the programming bar codes available in the PowerScan™ 9500 Family PRG. Check the corresponding features section for your interface, and also the Data Editing and Symbologies chapters of the PRG.

Using Programming Bar Codes

This manual contains bar codes which allow you to reconfigure your reader. Some programming bar code labels, like the "Reset Default Settings" on page 15, require only the scan of that single label to enact the change.

Other bar codes require the reader to be placed in Programming Mode prior to scanning them. Scan an ENTER/EXIT bar code once to enter Programming Mode; scan the desired parameter settings; scan the ENTER/EXIT bar code again to accept your changes, which exits Programming Mode and returns the reader to normal operation.

Configure Other Settings

Additional programming bar codes are available in the PRG to allow for customizing programming features. If your installation requires different programming than the standard factory default settings, refer to the PRG.

Resetting Product Defaults

If you aren't sure what programming options are in your reader, or you've changed some options and want your custom factory settings restored, scan the bar code below to reset the reader to its initial configuration. Reference the PRG for other options, and a listing of standard factory settings.



NOTE

Factory defaults are based on the interface type. Be sure your reader is configured for the correct interface before scanning this label. See "Selecting the Interface Type" on page 5 for more information.



Reset Default Settings

Reading Parameters

Move the reader toward the target and center the aiming pattern and illumination system to capture and decode the image. See [Using the PowerScan™ PD953X on page 4](#) for more information.

The aiming system will briefly switch off after the acquisition time, and if no code is decoded will switch on again before the next acquisition. The illuminator will remain on until the symbol is decoded.

As you read code symbols, adjust the distance at which you are holding the reader.

Good Read Green Spot Duration

Successful reading can be signaled by a good read green spot. Use the bar codes that follow to specify the duration of the good read pointer beam after a good read.



ENTER/EXIT PROGRAMMING MODE



Disabled



◆ Short (300 ms)



Medium (500 ms)



Long (800 ms)

Operating Modes

Scan Mode

The imager can be set to operate in one of several scanning modes. See the PRG for more information and settings for any of the options:

Trigger Single (Default) — This mode is associated with typical handheld reader operation. Motion Sense is active and if the scanner detects motion the aiming pattern is turned on. When the trigger is pulled, illumination is turned on and the scanner attempts to read a label. Scanning is activated until one of the following occurs:

- the programmable 'maximum scan on time'¹ has elapsed
- a label has been read
- the trigger is released

Trigger Pulse Multiple — Scanning begins when the trigger is pulled and continues after the trigger is released, until the trigger is pulled again or until the programmable 'maximum scan on time'¹ has elapsed. Reading a label does not disable scanning. Double Read Timeout¹ prevents undesired multiple reads while in this mode.

Trigger Hold Multiple — When the trigger is pulled, scanning starts and the product scans until the trigger is released or 'maximum scan on time'¹ has elapsed. Reading a label does not disable scanning. Double Read Timeout¹ prevents undesired multiple reads in this mode.

Always On — The illuminator is always ON and the reader is always ready for code reading. Double Read Timeout¹ prevents undesired multiple reads.

Flashing — The reader illuminator flashes on and off regardless of the trigger status. Code reading takes place only during the Flash On² time. Double Read Timeout¹ prevents undesired multiple reads.







Stand Mode — The scanner looks for changes within its field-of-view. The Aiming Pattern is always on to show the optimum reading area. If a predefined amount of movement is detected, the red illumination switches on. Scanning continues until a label is read or "maximum scan on time" is reached.

1. See the Product Reference Guide (PRG) for these and other programmable features
2. Controlled by Flash On Time and Flash Off Time. Use the PRG to program these options.

Scan Mode



ENTER/EXIT PROGRAMMING MODE

 <p>◆ Scan Mode = Trigger Single</p>	 <p>Scan Mode = Trigger Pulse Multiple</p>
 <p>Scan Mode = Trigger Hold Multiple</p>	 <p>Scan Mode = Flashing</p>
 <p>Scan Mode = Always On</p>	 <p>Scan Mode = Stand Mode</p>

Motion Aiming Control

This feature configures the ability of the scanner to Enable/Disable the Aiming system when motion is detected (Motionix™ motion-sensing technology). Scan the Enter/Exit Programming bar code above, then either of the barcodes below.

 <p>◆ Motion Aiming Control = Enable</p>	 <p>Motion Aiming Control = Disable</p>
---	--

Pick Mode

Specifies the ability of the reader to decode labels only when they are close to the center of the aiming pattern. Pick Mode is a Decoding and Transmission process where bar codes that are not within the configurable distance from the center of the aiming pattern are not acknowledged or transmitted to the host. It is active only while the scanner is in Trigger Single mode. If the scanner switches to a different Read Mode, Pick Mode is automatically disabled.



NOTE

This feature is not compatible with Multiple Labels Reading in a Volume. See the PRG for more information.



ENTER/EXIT PROGRAMMING MODE



◆ Pick Mode = Disable



Pick Mode = Enable

Multiple Label Reading

The reader offers a number of options for multiple label reading. See the PRG or software configuration tool for descriptions of these features and programming labels.

Technical Specifications

The following table contains Physical and Performance Characteristics, User Environment and Regulatory information.

Item	Description		
Physical Characteristics			
Dimensions	Height: 212 mm Length: 110 mm Width: 74 mm		
Weight (without cable)	330 gr (without cable)		
Electrical Characteristics			
Voltage & Current	PD953X/ PD953X- HP	PD953X- HPE	PD953X- DPM
Input Voltage	5 VDC +/- 5%	10 to 30 VDC	5 VDC +/-5%
Input Current			
Operating (typical):	335mA	220mA @ 10V	350mA
Operating (max):	475mA	300mA @ 10V	480mA
Idle/Standby (typical)	120mA	60mA @ 10V	120mA

Performance Characteristics		
Light Source	LED	
Roll (Tilt) Tolerance	$\pm 180^\circ$	
Pitch Tolerance	$\pm 40^\circ$	
Skew (Yaw) Tolerance	$\pm 40^\circ$	
Print Contrast Minimum	15% minimum reflectance	
	PD953X	PD953X-HP / PD953X-HPE
Resolution	Max resolution 1D 4 mils Max resolution 2D 7.5 mils	1D 2.5 mil 2D 4 mil
Depth of Field (Typical)^a		
Symbology	Standard Model:	High Performance:
Code 39	4 mils: 6-17 cm 20 mils: 4-55 cm 40 mils: 4-85 cm	2.5 mils: 2-6 cm 20 mils: 3-70 cm 40 mils: 3-110 cm
EAN 13	13 mils: 4-48 cm	13 mils: 3-60 cm
PDF-417	10 mils: 2-25 cm	10 mils: 2-30 cm
DataMatrix	7.5 mils: 7-14 cm 10 mils: 4-18 cm	4mil: 2-6 cm 10mil: 2-20 cm

- a. 13 mils DOF based on EAN. All other 1D codes are Code 39. All labels grade A, 300 lux ambient light, 20°C, label inclination 10°

Decode Capability	
1D Bar Codes	
GS1 Databar linear codes, UPC/EAN (A,E,13,8), UPC/EAN with P2/P5 Addons, UPC/EAN Coupons, ISBN, Code128, EAN128, ISBT128, Code39, Code39 Full ASCII, Code39 CIP, Code 32, Codabar, Interleaved 2 of 5, IATA, Industrial 2 of 5, Standard 2 of 5, Code11, MSI, Plessey, Code 93, Follet 2/5	
2D / Stacked Codes	
DataMatrix, MaxiCode and QR Codes(QR, Micro QR and Multiple QR codes), Aztec	
- Postal codes including: Australian Post, China Post, Japanese Post, KIX Post, Planet Code, Postnet, Royal Mail Code(RM45CC), IMB	
- stacked codes including EAN/JAN Composites; GS1 Databar Composites, GS1 Databar Expanded Stacked; GS1 DataBar Stacked; GS1 DataBar Stacked Omnidirectional; MacroPDF; Micro PDF417; PDF417; UPC A/E Composites, French CIP13, Grid Matrix(Chinese) code	
Interfaces Supported	RS-232, Keyboard Wedge, and USB. See page 5 for a listing of available interface options.
User Environment	
Operating Temperature	-4° to 122° F (-20° - +50° C)
Storage Temperature	-40° to 158° F (-40° to 70° C)
Humidity	0 to 95% non-condensing
Drop Specifications	Scanner withstands >50 times 6.5' (2 m) drops to concrete
Ambient Light Immunity	100,000 Lux
Contaminants: Spray/rain, Dust/particulates	IP65
ESD Level	20 KV
Beeper/Speaker	>= 80 dB @ 10 cm
Regulatory	See Regulatory Addendum

LED and Beeper Indications

The reader's beeper sounds and its LED illuminates to indicate various functions or errors on the reader. An optional 'Green Spot' also performs useful functions. The following tables list these indications. One exception to the behaviors listed in the tables is that the reader's functions are programmable, and so may or may not be turned on. For example, certain indications such as the power-up beep can be disabled using programming bar code labels.

Indicator	Description	LED	Beeper
Power-up Beep	The reader is in the process of powering-up.	N/A	Reader beeps four times at highest frequency and volume upon power-up.
Good Read Beep	A label has been successfully scanned by the reader.	LED behavior for this indication is configurable via the feature 'Good Read: When to Indicate' (see the PRG for information.)	The reader will beep once at current frequency, volume, mono/bi-tonal setting and duration upon a successful label scan.
ROM Failure	There is an error in the reader's software/programming	Flashes	Reader sounds one error beep at highest volume.
Limited Scanning Label Read	Indicates that a host connection is not established.	N/A	Reader 'chirps' six times at the highest frequency and current volume.
Reader Active Mode	The reader is active and ready to scan.	The LED is lit steadily ^a	N/A
Reader Disabled	The reader has been disabled by the host.	The LED blinks continuously	N/A

Indicator	Description	LED	Beeper
Green Spot ^a flashes momentarily	Upon successful read of a label, the software shall turn the green spot on for the time specified by the configured value.	N/A	N/A
Image Capture	When ready to capture image	Blue light flashes 2 times when updating	N/A

^aExcept when in sleep mode or when a Good Read LED Duration other than 00 is selected

Programming Mode - The following indications ONLY occur when the reader is in Programming Mode.

INDICATION	DESCRIPTION	LED	BEEPER
Label Programming Mode Entry	A valid programming label has been scanned.	LED blinks continuously	Reader sounds four low frequency beeps.
Label Programming Mode Rejection of Label	A label has been rejected.	N/A	Reader sounds three times at lowest frequency and current volume.
Label Programming Mode Acceptance of Partial Label	In cases where multiple labels must be scanned to program one feature, this indication acknowledges each portion as it is successfully scanned.	N/A	Reader sounds one short beep at highest frequency and current volume.
Label Programming Mode Acceptance of Programming	Configuration option(s) have been successfully programmed via labels and the reader has exited Programming Mode.	N/A	Reader sounds one high frequency beep and 4 low frequency beeps followed by reset beeps.
Label Programming Mode Cancel Item Entry	Cancel label has been scanned.	N/A	Reader sounds two times at low frequency and current volume.

Error Codes

Upon startup, if the reader sounds a long tone, this means the reader has not passed its automatic Selftest and has entered FRU (Field Replaceable Unit) isolation mode. If the reader is reset, the sequence will be repeated. Press and release the trigger to hear the FRU indication code.

The following table describes the LED flashes/beep codes associated with an error found.

Number of LED Flashes/Beeps	Error	Corrective Action
1	Configuration	Contact Helpdesk for assistance
2	Interface PCB	
6	Digital PCB	
11	Imager	

Cleaning

Exterior surfaces and scan windows exposed to spills, smudges or debris require periodic cleaning to ensure best performance during scanning.

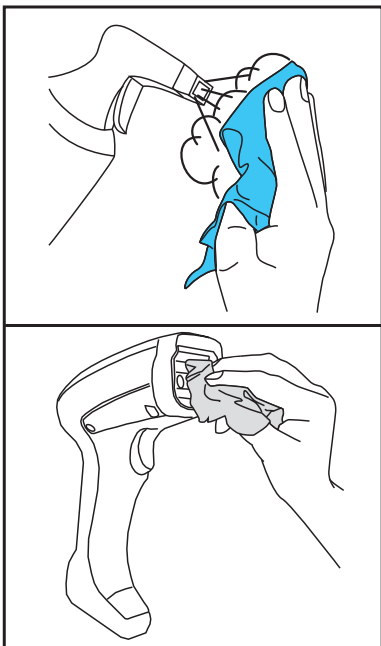

Use a soft, dry cloth to clean the product. If the product is very soiled, clean it with a soft cloth moistened with a diluted non-aggressive cleaning solution or diluted ethyl alcohol.



CAUTION

Do not use abrasive or aggressive cleansing agents or abrasive pads to clean scan windows or plastics.

Do not spray or pour liquids directly onto the unit.

Datalogic Limited Factory Warranty

Warranty Coverage

Datalogic warrants to Customer that Datalogic's products will be free from defects in materials and workmanship for a period of one year from product shipment. Datalogic ("Datalogic") hardware products are warranted against defects in material and workmanship under normal and proper use. The liability of Datalogic under this warranty is limited to furnishing the labor and parts necessary to remedy any defect covered by this warranty and restore the product to its normal operating condition. Repair or replacement of product during the warranty does not extend the original warranty term. Products are sold on the basis of specifications applicable at the time of manufacture and Datalogic has no obligation to modify or update products once sold.

If Datalogic determines that a product has defects in material or workmanship, Datalogic shall, at its sole option repair or replace the product without additional charge for parts and labor, or credit or refund the defective products duly returned to Datalogic. To perform repairs, Datalogic may use new or reconditioned parts, components, subassemblies or products that have been tested as meeting applicable specifications for equivalent new material and products. Customer will allow Datalogic to scrap all parts removed from the repaired product. The warranty period shall extend from the date of shipment from Datalogic for the duration published by Datalogic for the product at the time of purchase (Warranty period). Datalogic warrants repaired hardware devices against defects in workmanship and materials on the repaired assembly for a 90 day period starting from the date of shipment of the repaired product from Datalogic or until the expiration of the original warranty period, whichever is longer. Datalogic does not guarantee, and it is not responsible for, the maintenance of, damage to, or loss of configurations, data, and applications on the repaired units and at its sole discretion can return the units in the "factory default" configuration or with any software or firmware update available at the time of the repair (other than the firmware or software installed during the manufacture of the product). Customer accepts responsibility to maintain a back up copy of its software and data.

Warranty Claims Process

In order to obtain service under the Factory Warranty, Customer must notify Datalogic of the claimed defect before the expiration of the applicable Warranty period and obtain from Datalogic a return authorization number (RMA) for return of the product to a designated Datalogic service center. If Datalogic determines Customer's claim is valid, Datalogic will repair or replace product without additional charge for parts and labor. Customer shall be responsible for packaging and shipping the product to the designated Datalogic service center, with shipping charges prepaid. Datalogic shall pay for the return of the product to Customer if the shipment is to a location within the country in which the Datalogic service center is located. Customer shall be responsible for paying all shipping charges, duties, taxes, and any other charges for products returned to any other locations. Failure to follow the applicable RMA policy, may result in a processing fee. Customer shall be responsible for return shipment expenses for products which Datalogic, at its sole discretion, determines are not defective or eligible for warranty repair.

Warranty Exclusions

The Datalogic Factory Warranty shall not apply to:

- (i) any product which has been damaged, modified, altered, repaired or upgraded by other than Datalogic service personnel or its authorized representatives;
- (ii) any claimed defect, failure or damage which Datalogic determines was caused by faulty operations, improper use, abuse, misuse, wear and tear, negligence, improper storage or use of parts or accessories not approved or supplied by Datalogic;
- (iii) any claimed defect or damage caused by the use of product with any other instrument, equipment or apparatus;
- (iv) any claimed defect or damage caused by the failure to provide proper maintenance, including but not limited to cleaning the upper window in accordance with product manual;
- (v) any defect or damage caused by natural or man-made disaster such as but not limited to fire, water damage, floods, other natural disasters, vandalism or abusive events that would cause internal and external component damage or destruction of the whole unit, consumable items;
- (vi) any damage or malfunctioning caused by non-restoring action as for example firmware or software upgrades, software or hardware reconfigurations etc.;
- (vii) the replacement of upper window/cartridge due to scratching, stains or other degradation and/or
- (viii) any consumable or equivalent (e.g., cables, power supply, batteries, keypads, touch screen, triggers etc.).

No Assignment

Customer may not assign or otherwise transfer its rights or obligations under this warranty except to a purchaser or transferee of product. No attempted assignment or transfer in violation of this provision shall be valid or binding upon Datalogic.

DATALOGIC'S LIMITED WARRANTY IS IN LIEU OF ALL OTHER WARRANTIES, EXPRESS OR IMPLIED, ORAL OR WRITTEN, STATUTORY OR OTHERWISE, INCLUDING, WITHOUT LIMITATION, ANY IMPLIED WARRANTIES OF MERCHANTABILITY, FITNESS FOR A PARTICULAR PURPOSE, OR NONINFRINGEMENT. DATALOGIC SHALL NOT BE LIABLE FOR ANY DAMAGES SUSTAINED BY CUSTOMER ARISING FROM DELAYS IN THE REPLACEMENT OR REPAIR OF PRODUCTS UNDER THE ABOVE. THE REMEDY SET FORTH IN THIS WARRANTY STATEMENT IS THE CUSTOMER'S SOLE AND EXCLUSIVE REMEDY FOR WARRANTY CLAIMS. UNDER NO CIRCUMSTANCES WILL DATALOGIC BE LIABLE TO CUSTOMER OR ANY THIRD PARTY FOR ANY LOST PROFITS, OR ANY INCIDENTAL, CONSEQUENTIAL IN-DIRECT, SPECIAL OR CONTINGENT DAMAGES REGARDLESS OF WHETHER DATALOGIC HAD ADVANCE NOTICE OF THE POSSIBILITY OF SUCH DAMAGES.

Risk of Loss

Customer shall bear risk of loss or damage for product in transit to Datalogic. Datalogic shall assume risk of loss or damage for product in Datalogic's possession. In the absence of specific written instructions for the return of product to Customer, Datalogic will select the carrier, but Datalogic shall not thereby assume any liability in connection with the return shipment.

Ergonomic Recommendations



In order to avoid or minimize the potential risk of ergonomic injury follow the recommendations below. Consult with your local Health & Safety Manager to ensure that you are adhering to your company's safety programs to prevent employee injury.

- Reduce or eliminate repetitive motion
- Maintain a natural position
- Reduce or eliminate excessive force
- Keep objects that are used frequently within easy reach
- Perform tasks at correct heights
- Reduce or eliminate vibration
- Reduce or eliminate direct pressure
- Provide adjustable workstations
- Provide adequate clearance
- Provide a suitable working environment
- Improve work procedures.

Support Through the Website

Datalogic provides several services as well as technical support through its website. Log on to www.datalogic.com and click on the SUPPORT link which gives you access to:

- **Downloads** by selecting your product model from the dropdown list in the Search by Product field for specific Data Sheets, Manuals, Software & Utilities, and Drawings;
- **Repair Program** for On-Line Return Material Authorizations (RMAs) plus Repair Center contact information;
- **Customer Service** containing details about Maintenance Agreements;
- **Technical Support** through email or phone.



www.datalogic.com

©2013-2018 Datalogic S.p.A. and/or its affiliates.
All rights reserved. Datalogic and the Datalogic logo
are registered trademarks of Datalogic S.p.A. in
many countries, including the U.S.A. and the E.U.

Datalogic USA, Inc.

959 Terry Street | Eugene, OR 97402 | USA
Telephone: (541) 683-5700 | Fax: (541) 345-7140



820107114

(Rev B)

June 2018